

P/N T9970KT6
 TITLE 6' Ice Shield Assembly, Curved

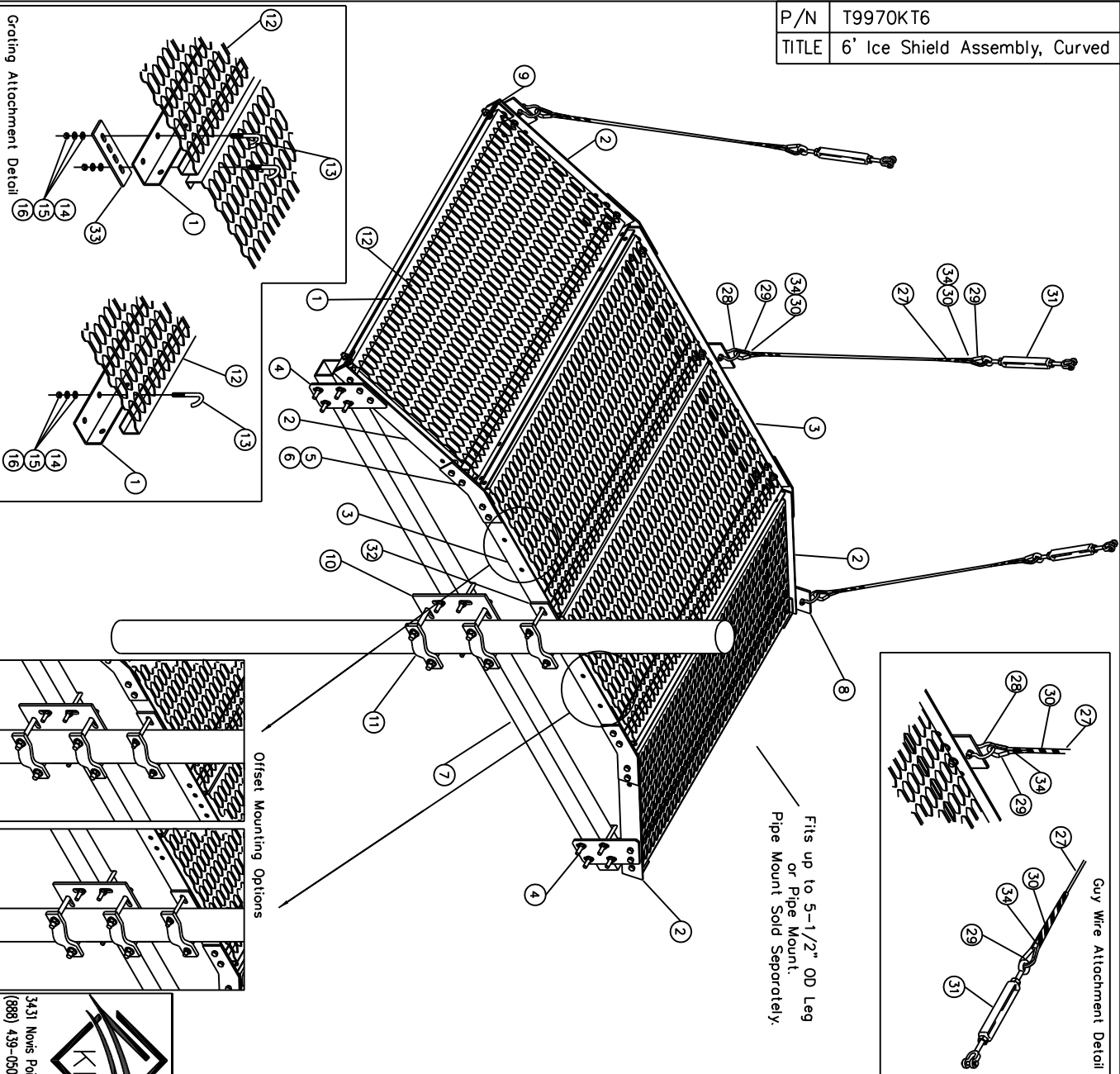

QTY	ITEM	PART NUMBER	DESCRIPTION
7	1	K9970KT-35	Angle, Grating, 50" Long
4	2	K9970KT-80	Angle, Incline, 25.5" Long
2	3	K9970KT-71	Angle, Horizontal, 49.5" Long
2	4	K9970KT-90	Plate, Tube Mount, 7 x 14" Plate
4	5	K9970KT-91	Plate, Bottom Angle Connector, 1/4" Plate
4	6	K9970KT-92	Plate, Side Angle Connector, 1/4" Plate
1	7	P1450KT8	Sq Tube, 96" Long
3	8	K9970KT-94	Plate-Guy Wire, 4.5" Plate
4	9	K9970KT-95	Corner Clip Angle, 3 x 3
1	10	K1710KT	Cross Pipe Plate
3	11	K1000KT8-534	Half Clamp, Medium
4	12	T3900KT10	Grating, 24" x 2" x 48" Long
16	13	H7826KT4	J-BOLT-3/8"
16	14	H2002KT38G	3/8" HEX NUT
16	15	H3002KT38G	3/8" LOCK WASHER
16	16	H3012KT38G	3/8" FLAT WASHER
6	17	H7940KT15SQ	1/2" Sq U-Bolt for 3" Sq Tube, Grade 5
2	18	K2120KT9I	Threaded Rod, 1/2" x 8", HDG
54	19	H1026KT112GA3	Bolt, 1/2" x 1-1/2" (A325) HH HDG
70	20	H2002KT12GA3	Nut, Hex, 1/2" HDG
70	21	H3012KT12GSAE	Flat Washer, 1/2" HDG
70	22	H3002KT12G	Lock Washer, 1/2" HDG
4	23	K2220KT8I	Threaded Rod, 5/8" x 8", HDG
8	24	H2002KT58G	Nut, Hex, 5/8" HDG
8	25	H3012KT58GSA3	Flat Washer, 5/8" HDG
8	26	H3002KT58G	Lock Washer, 5/8" HDG
100'	27	T9988MF	Guy Wire
3	28	T9012KT38	Shackle
6	29	T9003KT516	Thimble
6	30	T9013KT1/4	1/4" Dead End Grip for EHS Guy
3	31	T9000KT12-JE12	Jaw/Eye Turnbuckle
2	32	K4000KT	Shim Plate
2	33	K9921KT	Plate, Round Member Attachment
6	34	T9004KT14	End Sleeve for 1/4" Cable 1/pk

Weight: 395 lbs

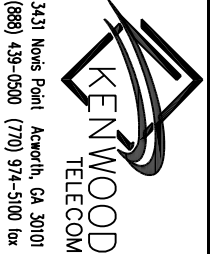

3431 Norris Point Acworth, GA 30101
 (888) 439-0500 (770) 974-5100 fax

DRAWING NO T9970KT6

REV SHEET 1 of 3

Grating Attachment Detail

Offset Mounting Options

Fits up to 5-1/2" OD Leg or Pipe Mount. Pipe Mount Sold Separately.

Guy Wire Attachment Detail

P/N T9970KT6
 TITLE 6' Ice Shield Assembly, Curved

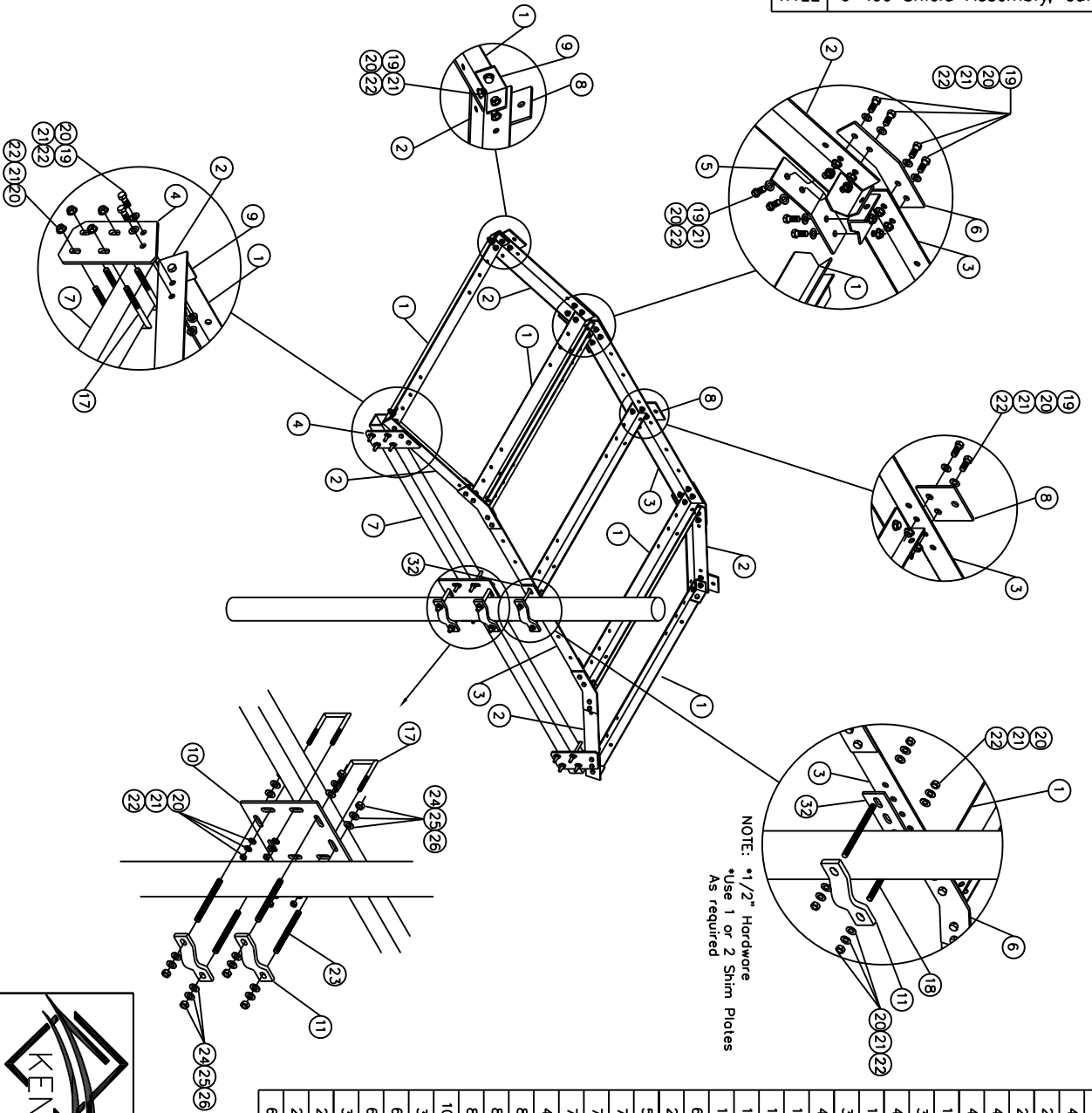

QTY	ITEM	PART NUMBER	DESCRIPTION
7	1	K9970KT-35	Angle, Grating, 50" Long
4	2	K9970KT-80	Angle, Incline, 25.5" Long
2	3	K9970KT-71	Angle, Horizontal, 49.5" Long
2	4	K9970KT-90	Plate, Tube Mount, 7 x 14" Plate
4	5	K9970KT-91	Plate, Bottom Angle Connector, 1/4" Plate
4	6	K9970KT-92	Plate, Side Angle Connector, 1/4" Plate
1	7	P1450KT8	Sq Tube, 96" Long
3	8	K9970KT-94	Plate-Guy Wire, 4.5" Plate
4	9	K9970KT-95	Corner Clip Angle, 3 x 3
1	10	K1710KT	Cross Pipe Plate
3	11	K1000KT8-534	Half Clamp, Medium
4	12	T3900KT10	Grating, 24" x 2" x 48" Long
16	13	H7826KT4	J-BOLT-3/8"
16	14	H2002KT38G	3/8" HEX NUT
16	15	H3002KT38G	3/8" LOCK WASHER
16	16	H3012KT38G	3/8" FLAT WASHER
6	17	H7940KT15SD	1/2" Sq U-Bolt for 3" Sq Tube, Grade 5
2	18	K2120KT9I	Threaded Rod, 1/2" x 8", HDG
54	19	H1026KT112GA3	Bolt, 1/2" x 1-1/2" (A325) HH HDG
70	20	H2002KT12GA3	Nut, Hex, 1/2" HDG
70	21	H3012KT12GSAE	Flat Washer, 1/2" HDG
70	22	H3002KT12G	Lock Washer, 1/2" HDG
4	23	K2220KT8I	Threaded Rod, 5/8" x 8", HDG
8	24	H2002KT58G	Nut, Hex, 5/8" HDG
8	25	H3012KT58GSA3	Flat Washer, 5/8" HDG
8	26	H3002KT58G	Lock Washer, 5/8" HDG
100'	27	T9988BMF	Guy Wire
3	28	T9012KT38	Shackle
6	29	T9003KT516	Thimble
6	30	T9013KT1/4	1/4" Dead End Grip for EHS Guy
3	31	T9000KT12-JE12	Jaw/Eye Turnbuckle
2	32	K4000KT	Shim Plate
2	33	K9921KT	Plate, Round Member Attachment
6	34	T9004KT14	End Sleeve for 1/4" Cable 1/pk



KENWOOD
TELECOM

3431 Novis Point Acworth, GA 30011
 (888) 439-0500 (770) 974-5100 fax

6' Ice Shield Assembly
 Curved Design

DRAWN
KAA

DATE
1/11/10

CHECKED

DATE

DRAWING NO
T9970KT6

REV SHEET
OF 3

P/N	T9970KT6
TITLE	6' Ice Shield Assembly, Curved

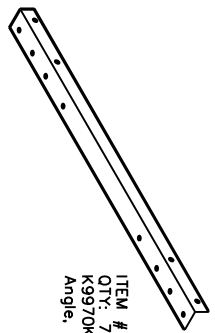

ITEM # 1
QTY: 7
K9970KT-35
Angle, Grating, 50" Long

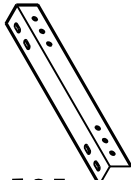

ITEM # 2
QTY: 4
K9970KT-80
Angle, Incline, 25.5" Long

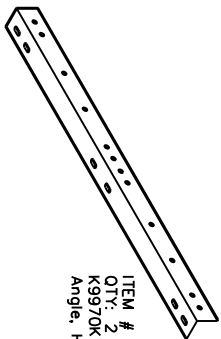

ITEM # 3
QTY: 2
K9970KT-71
Angle, Horizontal, 48.5" Long

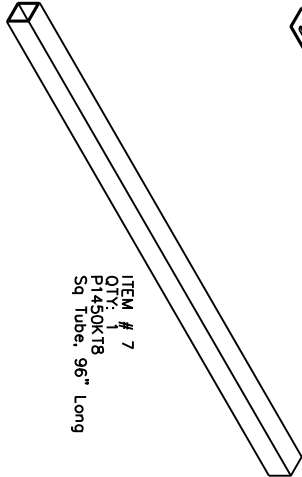

ITEM # 7
QTY: 1
P1450KT8
Sq Tube, 96" Long



ITEM # 6
QTY: 4
K9970KT-92
Plate, Side Angle Connector, 1/4" Plate



ITEM # 5
QTY: 4
K9970KT-91
Plate, Bottom Angle Connector, 1/4" Plate

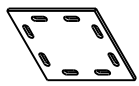

ITEM # 10
QTY: 1
K1710KT
Cross Pipe Plate



ITEM # 4
QTY: 2
K9970KT-90
Plate, Tube Mount, 7 x 14" Plate



ITEM # 32
QTY: 2
K4000KT
Shim Plate



ITEM # 11
QTY: 3
K1000KT8-534
Half Clamp, Medium



ITEM # 9
QTY: 4
K9970KT-95
Corner Clip Angle, 3 x 3



ITEM # 8
QTY: 3
K9970KT-94
Plate-Guy Wire, 4.5" Plate



ITEM # 33
QTY: 2
K9921KT
Plate-Round Member Attachment

QTY	ITEM	PART NUMBER	DESCRIPTION
7	1	K9970KT-35	Angle, Grating, 50" Long
4	2	K9970KT-80	Angle, Incline, 25.5" Long
2	3	K9970KT-71	Angle, Horizontal, 49.5" Long
4	4	K9970KT-90	Plate, Tube Mount, 7 x 14" Plate
4	5	K9970KT-91	Plate, Bottom Angle Connector, 1/4" Plate
4	6	K9970KT-92	Plate, Side Angle Connector, 1/4" Plate
1	7	P1450KT8	Sq Tube, 96" Long
3	8	K9970KT-94	Plate-Guy Wire, 4.5" Plate
4	9	K9970KT-95	Corner Clip Angle, 3 x 3
1	10	K1710KT	Cross Pipe Plate
3	11	K1000KT8-534	Half Clamp, Medium
4	12	T3900KT10	Grating, 24" x 2" x 48" Long
16	13	H7826KT4	J-BOLT-3/8"
16	14	H2002KT38G	3/8" HEX NUT
16	15	H3002KT38G	3/8" LOCK WASHER
16	16	H3012KT38G	3/8" FLAT WASHER
6	17	H7940KT15SQ	1/2" Sq U-Bolt for 3" Sq Tube, Grade 5
2	18	K2120KT9I	Threaded Rod, 1/2" x 8", HDG
54	19	H1026KT112GGA3	Bolt, 1/2" x 1-1/2" (A325) HH HDG
70	20	H2002KT12GGA3	Nut, Hex, 1/2" HDG
70	21	H3012KT12GSAE	Flat Washer, 1/2" HDG
70	22	H3002KT12G	Lock Washer, 1/2" HDG
4	23	K2220KT8I	Threaded Rod, 5/8" x 8", HDG
8	24	H2002KT58G	Nut, Hex, 5/8" HDG
8	25	H3012KT58GSA3	Flat Washer, 5/8" HDG
8	26	H3002KT58G	Lock Washer, 5/8" HDG
100'	27	T9988WF	Guy Wire
3	28	T9012KT138	Shackle
6	29	T9003KT516	Thimble
6	30	T9013KT1/4	1/4" Dead End Grip for EHS Guy
3	31	T9000KT12-EI12	Jaw/Eye Turnbuckle
2	32	K4000KT	Shim Plate
2	33	K9921KT	Plate, Round Member Attachment
6	34	T9004KT14	End Sleeve for 1/4" Cable 1/pk

3431 Nons Point Acworth, GA 30101
(888) 439-0500 (770) 974-5100 fax

DRAWN	DATE	CHECKED	DATE
KAJA	1/11/10		

6' Ice Shield Assembly
Curved Design

DRAWING NO T9970KT6

REV	SHEET
	3